

IDRJA

Valvole di ritegno in acciaio inox stampato / Check valves fabricated from pressed stainless steel



Modello / Model
IDRJA

Materiale / Material
Aisi 304 - 316

Tenuta / Seal
NBR, FPM, PTFE, FEP

DN
20 – 100

PN
16

Caratteristiche tecniche / Construction features

- **Lavorazione: acciaio inox stampato** / Manufacturing process: pressed stainless steel
- **Trattamento superficiale sgrassaggio, decapaggio ed elettrolucidatura** / Surface treatment degreasing, pickling and electropolishing
- **Tenuta / Seal ring**
NBR, FPM, PTFE o/or FEP
- **Connessioni filettate femmina secondo** / Threaded ends female according to UNI ISO 228/1
- **Saldatura a TIG senza apporto di materiale** / TIG weldings without additional material
- **Pressione di apertura** / Opening pressure
Min. 0,025 – Max. 0,035 bar
- **Test idraulico di tenuta guarnizioni** / Hydraulic test on the seal rings
0.2 bar
- **Pressione nominale di esercizio** / Nominal working pressure
16 bar
- **Temperatura di esercizio** / Working temperature
-25°C – +90°C NBR
-20°C – +150°C FPM
-20°C – +200°C PTFE o/or FEP
- **Certificazioni** / Approvals
 NSF/ANSI 61
(solo versioni Aisi 316 FPM / only Aisi 316 FPM types)

Diagramma pressione temperatura / Pressure temperature diagram



Perdite di carico / Friction losses diagrams



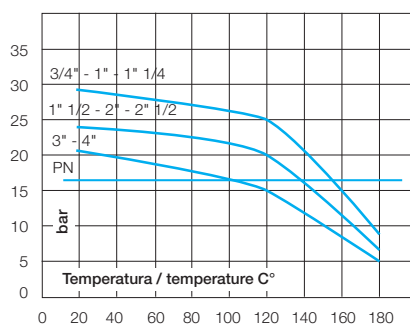
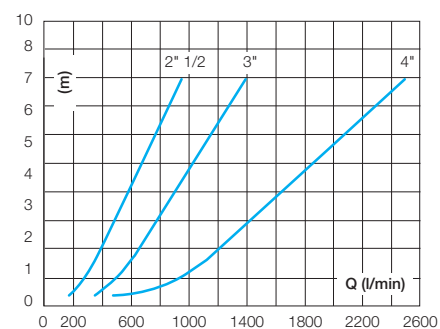
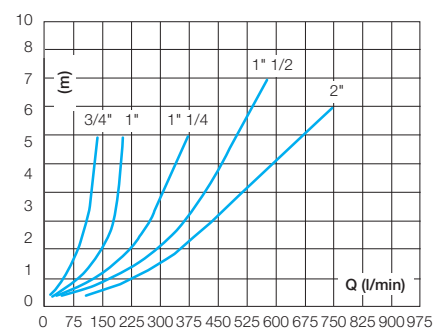
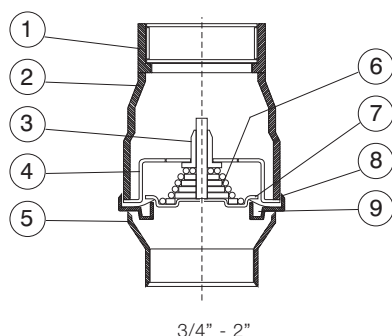

3/4" - 2"

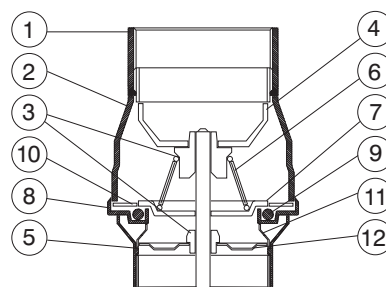

2" 1/2 - 4"

Componenti e materiali / Components and materials

	Versione Aisi 304 Version Aisi 304	Versione Aisi 316 Version Aisi 316
1 Manicotto lato mandata / Outlet end	1.4301 / 1.4304 EN 10088	1.4401 / 1.4404 EN 10088
2 Corpo / Valve	1.4301 / 1.4304 EN 10088	1.4401 / 1.4404 EN 10088
3 Boccola di guida / Guide bush	PTFE	PTFE
4* Guida otturatore / Flow control disc guide	1.4301 / 1.4304 EN 10088	1.4401 / 1.4404 EN 10088
5 Manicotto lato aspirazione / Inlet end	1.4301 / 1.4304 EN 10088	1.4401 / 1.4404 EN 10088
6* Molla / Spring	1.4301 / 1.4304 EN 10088	1.4401 / 1.4404 EN 10088
7* Otturatore / Flow control disc	1.4301 / 1.4304 EN 10088	1.4401 / 1.4404 EN 10088
8 Contenitore anello di tenuta / Seal ring housing	1.4301 / 1.4304 EN 10088	1.4401 / 1.4404 EN 10088
9* Anello di tenuta / Seal ring	NBR, FPM	FPM, PTFE, FEP
10 Anello ferma tenuta / Seal ring retainer	1.4301 / 1.4304 EN 10088	1.4401 / 1.4404 EN 10088
11 Supporto contenitore tenuta / Seal ring support	1.4301 / 1.4304 EN 10088	1.4401 / 1.4404 EN 10088
12 Guida lato aspirazione / Inlet side guide	1.4301 / 1.4304 EN 10088	1.4401 / 1.4404 EN 10088

* **Ricambi disponibili solo per versioni** / Spare parts only for versions: 2" 1/2 - 3" - 4"

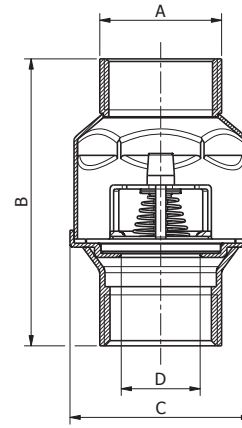

Dimensioni e pesi / Dimensions and weights

Codice Code	Misura Size	Materiale Material	Tenuta Seal	DN	PN	Peso in gr. Weight in gr.	KV m ³ /h	Dimensioni in mm Dimensions in mm			
								A	B	C	D
900011	3/4"	Aisi 304	NBR	20	16	129	10,8	30	67	44	18,3
900016	1"			25	16	191	18,7	35,8	83	53	23,4
900021	1" 1/4			32	16	281	31,5	45	97	66	31,4
900026	1" 1/2			40	16	388	40,5	50,8	115	78	36,8
900029	2"			50	16	704	56	63	120,5	89	42,9
900055	2" 1/2			65	16	1.425	69	80	142	113	58,7
900012	3/4"	Aisi 304	FPM	20	16	129	10,8	30	67	44	18,3
900017	1"			25	16	191	18,7	35,8	83	53	23,4
900022	1" 1/4			32	16	281	31,5	45	97	66	31,4
900027	1" 1/2			40	16	388	40,5	50,8	115	78	36,8
900030	2"			50	16	704	56	63	120,5	89	42,9
900057	2" 1/2			65	16	1.425	69	80	142	113	58,7
900402	3/4"	Aisi 316	FPM	20	16	129	10,8	30	67	44	18,3
900412	1"			25	16	191	18,7	35,8	83	53	23,4
900422	1" 1/4			32	16	281	31,5	45	97	66	31,4
900432	1" 1/2			40	16	388	40,5	50,8	115	78	36,8
900442	2"			50	16	704	56	63	120,5	89	42,9
900452	2" 1/2			65	16	1.425	69	80	142	113	58,7
900462	3"			80	16	2.085	99	93	160	132	70,3
900472	4"			100	16	3.415	181	120	191	167	93,4
900403	3/4"	Aisi 316	PTFE	20	16	129	10,8	30	74	44	18,3
900415	1"			25	16	250	18,7	35,8	90	53	23,4
900424	1" 1/4			32	16	365	31,5	45	101	66	31,4
900433	1" 1/2			40	16	525	40,5	50,8	120	78	36,8
900443	2"	Aisi 316	FEP	50	16	704	56	63	120,5	89	42,9
900455	2" 1/2			65	16	1.425	69	80	142	113	58,7
900465	3"			80	16	2.085	99	93	160	132	70,3
900475	4"			100	16	3.415	181	120	191	167	93,4

Modello / Model
IDRJA / OR

Materiale / Material
Aisi 304 - 316

Tenuta / Seal
FPM

DN
20 - 32

PN
16



Caratteristiche tecniche / Construction features

- **Adatta ad utilizzo con aria compressa o vuoto in applicazioni non gravose** / For use with compressed air or vacuum in low impact applications
- **Otturatore: acciaio inossidabile Aisi 316 con saldatura rinforzata tra perno e disco** / Flow control disc: stainless steel Aisi 316 with reinforced welding between guiding pin and disc
- **Connessioni filettate femmina secondo** / Threaded ends female according to UNI ISO 228/1
- **Temperatura di esercizio** / Working temperature
-20°C - +150°C
- **Certificazioni** / Approvals
 NSF/ANSI 81
(solo versione Aisi 316 FPM / only Aisi 316 FPM type)

Dimensioni e pesi / Dimensions and weights

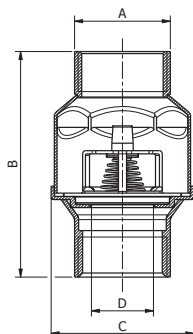

Codice Code	Misura Size	Materiale Material	DN	PN	Peso in gr. Weight in gr.	KV m³/h	Dimensioni in mm Dimensions in mm			
							A	B	C	D
900012R	3/4"	Aisi 304	20	16	129	10,8	30	67	44	18,3
900017R	1"		25	16	191	18,7	35,8	83	53	23,4
900022R	1" 1/4		32	16	281	31,5	45	97	66	31,4
900402R	3/4"	Aisi 316	20	16	129	10,8	30	67	44	18,3
900412R	1"		25	16	191	18,7	35,8	83	53	23,4
900422R	1" 1/4		32	16	281	31,5	45	97	66	31,4

Modello / Model
IDRJA / TYPE EA

Materiale / Material
Aisi 304

Tenuta / Seal
FPM

DN
20 - 50

PN
16



Caratteristiche tecniche / Construction features

- **Versione antinquinamento controllabile** / Antipollution checkable version
- **Conforme a** / In conformity with UNI EN 1717 (tipo / type EA)
- **Foro di ispezione 1/8" gas maschio con tappo su lato aspirazione** / 1/8" male inspection hole with cap on suction side
- **Connessioni filettate femmina secondo** / Threaded ends female according to UNI ISO 228/1
- **Temperatura di esercizio** / Working temperature
-20°C - +150°C

Dimensioni e pesi / Dimensions and weights

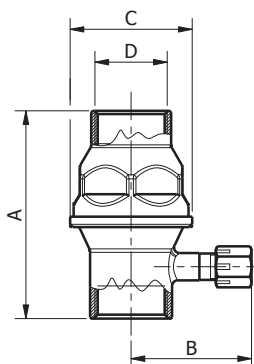

Codice Code	Misura Size	DN	PN	Peso in gr. Weight in gr.	KV m³/h	Dimensioni in mm Dimensions in mm			
						A	B	C	D
900012T	3/4"	20	16	170	10,8	77	42	44	3/4" F
900017T	1"	25	16	198	18,7	94	45	53	1" F
900022T	1" 1/4	32	16	300	31,5	107	49	66	1" 1/4 F
900027T	1" 1/2	40	16	443	40,5	125	52	78	1" 1/2 F
900030T	2"	50	16	672	56	125	58	90	2" F

Modello / Model
IDRJA / DW

Materiale / Material
Aisi 304 - 316

Tenuta / Seal
EPDM

DN
20 – 100

PN
16



Caratteristiche tecniche / Construction features

- **Per acqua potabile / For drinkable water**
- **Conforme a / In conformity with**
UNI EN 1074-3
- **Temperatura di esercizio / Working**
temperature
-20°C – +110°C
- **Connessioni filettate femmina secondo /**
Threaded ends female according to
UNI ISO 228/1
- **Certificazioni / Approvals**



WRAS



NSF/ANSI 61

(solo versione Aisi 304 /
only Aisi 304 version)

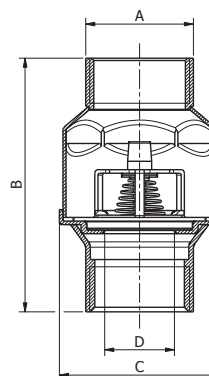

Dimensioni e pesi / Dimensions and weights

Codice Code	Misura Size	Materiale Material	DN	PN	Peso in gr. Weight in gr.	KV m ³ /h	Dimensioni in mm Dimensions in mm			
							A	B	C	D
900010A	3/4"	Aisi 304	20	16	129	10,8	30	67	44	18,3
900015A	1"		25	16	191	18,7	35,8	83	53	23,4
900020A	1" 1/4		32	16	281	31,5	45	97	66	31,4
900025A	1" 1/2		40	16	388	40,5	50,8	115	78	36,8
900028A	2"		50	16	704	56	63	120,5	89	42,9
900056A	2" 1/2		65	16	1.425	69	80	142	113	58,7
900400A	3/4"	Aisi 316	20	16	129	10,8	30	67	44	18,3
900410A	1"		25	16	191	18,7	35,8	83	53	23,4
900420A	1" 1/4		32	16	281	31,5	45	97	66	31,4
900430A	1" 1/2		40	16	388	40,5	50,8	115	78	36,8
900440A	2"		50	16	704	56	63	120,5	89	42,9
900451A	2" 1/2		65	16	1.425	69	80	142	113	58,7
900461A	3"		80	16	2.085	99	93	160	132	70,3
900471A	4"		100	16	3.415	181	120	191	167	93,4

Modello / Model
IDRJA / MF

Materiale / Material
Aisi 304

Tenuta / Seal
FPM

DN
25 – 50

PN
16

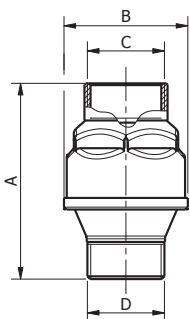

Caratteristiche tecniche / Construction features

- **Maschio – femmina / Male – female**
- **Connessione lato aspirazione filettata maschio secondo / Threaded ends on suction side male according to UNI ISO 228/1**
- **Connessione lato mandata filettata femmina secondo / Threaded ends on delivery side female according to UNI ISO 228/1**

- **Temperatura di esercizio / Working temperature**
-20°C – +150°C

Dimensioni e pesi / Dimensions and weights

Codice Code	Misura Size	DN	PN	Peso in gr. Weight in gr.	KV m³/h	Dimensioni in mm Dimensions in mm			
						A	B	C	D
900017MF	1"	25	16	167	18,7	76	53	1" F	1" M
900022MF	1" 1/4	32	16	261	31,5	99	66	1"1/4 F	1"1/4 M
900027MF	1" 1/2	40	16	383	40,5	115	78	1"1/2 F	1"1/2 M
900030MF	2"	50	16	596	56	123	90	2" F	2" M

Modello / Model
IDRJA / MFA

Materiale / Material
Aisi 304

Tenuta / Seal
EPDM

DN
25 – 50

PN
16

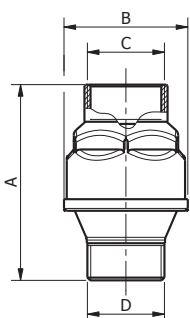

Caratteristiche tecniche / Construction features

- **Maschio – femmina / Male - female**
- **Connessione lato aspirazione filettata maschio / Threaded ends on suction side male UNI ISO 228/1**
- **Connessione lato mandata filettata femmina / Threaded ends on delivery side female UNI ISO 228/1**

- **Temperatura di esercizio / Working temperature**
-20°C – +110°C

- **Certificazioni / Approvals**



Dimensioni e pesi / Dimensions and weights

Codice Code	Misura Size	DN	PN	Peso in gr. Weight in gr.	KV m³/h	Dimensioni in mm Dimensions in mm			
						A	B	C	D
900017MFA	1"	25	16	167	18,7	76	53	1" F	1" M
900022MFA	1" 1/4	32	16	261	31,5	99	66	1" 1/4 F	1" 1/4 M
900027MFA	1" 1/2	40	16	383	40,5	115	78	1" 1/2 F	1" 1/2 M
900030MFA	2"	50	16	596	56	123	90	2" F	2" M

Modello / Model
IDRJA / NPT

Materiale / Material
Aisi 316

Tenuta / Seal
FPM

DN
20 – 50

PN
16



Caratteristiche tecniche / Construction features

- **Otturatore con saldatura rinforzata tra perno e disco. Adatta ad uso con aria compressa in applicazioni non gravose** / Flow control disc with reinforced welding between guiding pin and disc for use with compressed air in low impact applications
- **Conessioni filettate femmina gas coniche NPT secondo / Female threaded ends NPT according to ANSI B 1.20.1**

- **Temperatura di esercizio / Working temperature**
-20°C – +150°C

- **Certificazioni / Approvals**



NSF/ANSI 61

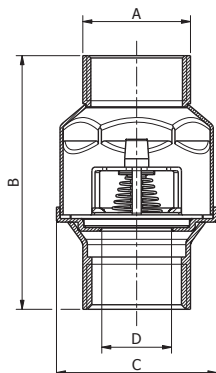

Dimensioni e pesi / Dimensions and weights

Codice Code	Misura Size	DN	PN	Peso in gr. Weight in gr.	KV m³/h	Dimensioni in mm Dimensions in mm			
						A	B	C	D
900402NPTR	3/4"	20	16	129	10,8	30	67	44	18,3
900412NPTR	1"	25	16	191	18,7	35,8	83	53	23,4
900422NPTR	1" 1/4	32	16	281	31,5	45	97	66	31,4
900432NPTR	1" 1/2	40	16	388	40,5	50,8	115	78	36,8
900442NPTR	2"	50	16	704	56	63	120,5	89	42,9

Modello / Model

IDRJA / CON FILTRO E PORTAGOMMA

Materiale / Material
Aisi 304

Tenuta / Seal
NBR

DN
25 – 50

PN
16



Caratteristiche tecniche / Construction features

- **Valvola di fondo con raccordo portagomma** / Foot valve with hose nipple
- **Anello per collegamento galleggiante** / Hook for float connection
- **Grado di filtrazione / Filtration**
U.S. mesh: 18 (10 per / for 2")
- **Trattamento superficiale: sgrassaggio, decapaggio ed elettrolucidatura** / Surface treatment degreasing, pickling and electropolishing
- **Temperatura di esercizio / Working temperature**
-20°C – +90°C FPM

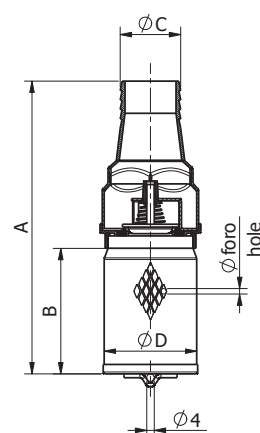

Dimensioni e pesi / Dimensions and weights

Codice Code	Misura Size	DN	PN	Peso in gr. Weight in gr.	KV m³/h	Dimensioni in mm Dimensions in mm				Foro rete Net hole
						A	B	Ø C	Ø D	Ø mm
900037	1"	25	16	175	18,7	157	70	26	49	1
900038	1"	25	16	190	18,7	157	70	32	49	1
900041	1"1/4	32	16	285	31,5	175	70	38	49	1
900043	2"	50	16	690	56	220	82	50	79	1.8

Modello / Model
IDRJA / FM +

Materiale / Material
Aisi 304

Tenuta / Seal
NBR

DN
25 – 50

PN
16



Caratteristiche tecniche / Construction features

- **Femmina-maschio con attacco lato mandata** / Female-male with connection on delivery side
- **Connessioni filettate secondo** / Threaded ends according to UNI ISO 228/1
- **Temperatura di esercizio** / Working temperature
-25°C – +90°C

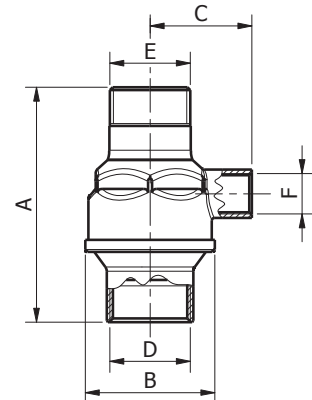

Dimensioni e pesi / Dimensions and weights

Codice Code	Misura Size	DN	PN	Peso in gr. Weight in gr.	KV m³/h	Dimensioni in mm Dimensions in mm					
						A	B	C	D	E	F
900016A	1"	25	16	200	18,7	97	53	42	1" F	1" M	3/8" F
900021A	1" 1/4	32	16	305	31,5	113	66	48	1"1/4 F	1"1/4 M	3/8" F
900026A	1" 1/2	40	16	430	40,5	130	78	54	1"1/2 F	1"1/2 M	3/8" F
900029A	2"	50	16	660	56	133	90	60	2" F	2" M	3/8" F

Modello / Model
IDRJA / VCT

Materiale / Material
Aisi 304

Tenuta / Seal
FPM

DN
25 – 50

PN
16



Caratteristiche tecniche / Construction features

- **Connessioni tipo** / Ends type
Victaulic®
- **Temperatura di esercizio** / Working temperature
-20°C – +150°C

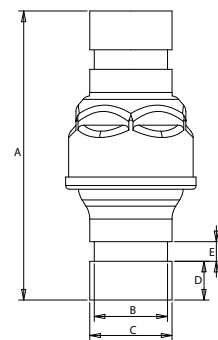

Dimensioni e pesi / Dimensions and weights

Codice Code	Misura Size	DN	PN	Peso in gr. Weight in gr.	KV m³/h	Dimensioni in mm Dimensions in mm				
						A	B	C	D	E
900017VCT	1"	25	16	210	18,7	120	30	33.7	15.9	8
900022VCT	1" 1/4	32	16	310	31,5	126	38.8	42.4	15.9	8
900027VCT	1" 1/2	40	16	430	40,5	140.7	44.9	48.3	15.9	8
900030VCT	2"	50	16	775	56	160.9	57	60.3	15.9	8

Modello / Model
IDRJA / FLANGIATA

Materiale / Material
Aisi 304 - 316

Tenuta / Seal
FPM

DN
50 – 100

PN
16



Caratteristiche tecniche / Construction features

■ **Connessioni flangiate: flange in acciaio inox stampato con foratura secondo /**
Flanged ends: flanges fabricated from pressed stainless steel with holes according to UNI EN 1092-1 PN 16

■ **Temperatura di esercizio / Working temperature**
-20°C – +150°C

Dimensioni e pesi / Dimensions and weights

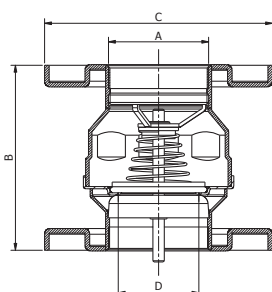

Codice Code	Materiale Material	DN	PN	Peso in gr. Weight in gr.	KV m ³ /h	Dimensioni in mm Dimensions in mm				Flange Flanges	
						A	B	C	D	N° fori N. holes	Diam. fori Diam. holes
900350	Aisi 304	50	16	1.950	56	64	123	165	42,9	4	18
900360		65	16	3.245	69	80	145	185	58,7	4	18
900355	Aisi 316	50	16	1.950	56	64	123	165	42,9	4	18
900365		65	16	3.245	69	80	145	185	58,7	4	18
900375		80	16	4.135	99	93	164	200	70,4	8	18
900385		100	16	6.685	181	120	196	225	93,4	8	18

Modello / Model
IDRJA / DI FONDO

Materiale / Material
Aisi 304 - 316

Tenuta / Seal
FPM

DN
50 – 100

PN
16



Caratteristiche tecniche / Construction features

■ **Connessione flangiata: flangia in acciaio inox stampato con foratura secondo /**
Flanged end: flange fabricated from pressed stainless steel with holes according to UNI EN 1092-1 PN 16

■ **Temperatura di esercizio / Working temperature**
-20°C – +150°C

Dimensioni e pesi / Dimensions and weights

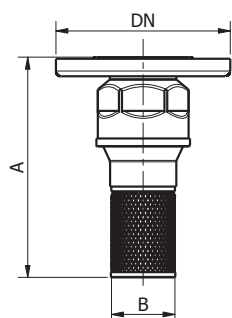

Codice Code	Misura Size	Materiale Material	DN	PN	Peso in gr. Weight in gr.	KV m ³ /h	Dimensioni in mm Dimensions in mm		
							A	B	Ø foro Ø net hole
900350F	2"	Aisi 304	50	16	1.453	56	208	60	1
900360F	2" 1/2		65	16	2.242	69	235	79	1.8
900355F	2"	Aisi 316	50	16	1.453	56	208	60	1
900365F	2" 1/2		65	16	2.242	69	235	79	1.8
900375F	3"		80	16	2.950	99	266	92	1.8
900385F	4"		100	16	5.012	181	321	115	1.8

* **Misure flangia: vedi tabella superiore /** Flange dimensions: see above table